

PROJECTION SPEAKERS

PJ-304

Thank you for purchasing TOA's Projection Speakers. Please carefully follow the instructions in this manual to ensure long, trouble-free use of your equipment.

1. SAFETY PRECAUTIONS

- Before installation or use, be sure to carefully read all the instructions in this section for correct and safe operation.
- Be sure to follow all the precautionary instructions in this section, which contain important warnings and/or cautions regarding safety.
- After reading, keep this manual handy for future reference.

WARNING

Indicates a potentially hazardous situation which, if mishandled, could result in death or serious personal injury.

- Install the unit only in a location that can structurally support the weight of the unit and the mounting bracket. Doing otherwise may result in the unit falling down and causing personal injury and/or property damage.

3. SPECIFICATIONS

Model No.		PJ-304
Enclosure	Bass-reflex type	
Rated Input	30 W (100 V, 70 V line, 8 Ω)	
Rated Impedance	Low	8 Ω
	100 V line	330 Ω (30 W), 500 Ω (20 W), 670 Ω (15 W), 1 kΩ (10 W), 2 kΩ (5 W)
	70 V line	170 Ω (30 W), 250 Ω (20 W), 330 Ω (15 W), 500 Ω (10 W), 1 kΩ (5 W)
Sensitivity (500 – 5,000 Hz, pink noise)	91 dB (1 W, 1 m)	
Frequency Response	70 – 20,000 Hz (at 20 dB below peak)	
Speaker Component	12 cm (5") cone type + balanced dome-tweeter	
Speaker Cord	2-core cabtyre cord with diameter of 6 mm (0.24")	
Finish	Enclosure: HIPS resin, off white (RAL 9010 or equivalent color) Grille: Surface-treated steel plate net, off white (RAL 9010 or equivalent color), paint	
Dimensions (unit only)	ø186 x 251 (h) mm (ø7.32" x 9.88")	
Weight (unit only)	2.1 kg (4.63 lb)	
Accessories	Swivel bracket 1, Tapping screw 4 x 16 3	

Note: The design and specifications are subject to change without notice for improvement.

- Do not use other methods than specified to mount the bracket. Extreme force is applied to the unit and the unit could fall off, possibly resulting in personal injuries.
- Tighten all screws securely. If any is loosely fixed, this may cause the unit to fall, resulting in personal injury.

CAUTION

Indicates a potentially hazardous situation which, if mishandled, could result in moderate or minor personal injury, and/or property damage.

- To avoid electric shocks, be sure to switch off the amplifier's power when connecting speakers.
- Do not operate the unit for an extended period of time with the sound distorting. This is an indication of a malfunction, which in turn can cause heat to generate and result in a fire.
- Do not hang down from the unit as this may cause it to fall down or drop, resulting in personal injury and/or property damage.

2. GENERAL DESCRIPTION

The PJ-304 are projection speakers designed for ceiling and wall installations. Considered in architectural design, they can blend in with lighting equipment.

The supplied swivel bracket allows for flexible speaker angle adjustment.

The PJ-304 is driven on both high-impedance (100 V and 70 V) and low-impedance (8 Ω) lines. The input power (impedance) can be easily changed at the upper side of the speaker. The speakers are easy to repaint so as to meet a wide range of design needs

4. WIRING DIAGRAMS

4.2. PJ-304

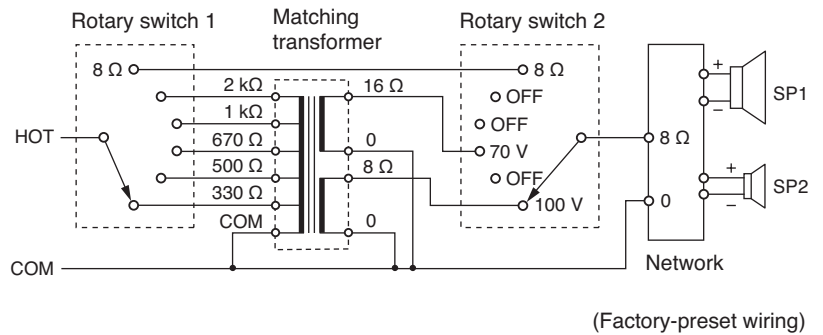

5. INPUT POWER (IMPEDANCE) CHANGE

Important

Be sure to follow the instructions below. Failure to do so may cause damage to the speaker.

- Switch off the amplifier's power when changing the input power.
- Never make 8 Ω connection in a 100 V or 70 V line system, as excessive input power is applied to the speaker, possibly resulting in damage. (PJ-304)

5.2. PJ-304

The input power (impedance) is factory-preset to 30 W (330 Ω) for 100 V line.

When changing this setting, use a standard screwdriver to rotate the rotary switches on the upper side of the speaker to the desired position.

Input power	30 W	20 W	15 W	10 W	5 W
100 V line	330 Ω	500 Ω	670 Ω	1 kΩ	2 kΩ
70 V line	170 Ω	250 Ω	330 Ω	500 Ω	1 kΩ

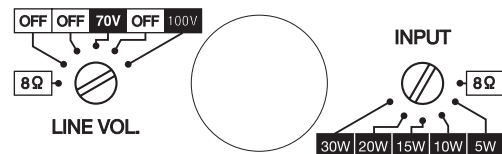

Note

Shown above is an example when the input power is set to 20 W on 100 V line.

- (1) When operating at high impedance (100 V and 70 V lines);
Set the rotary switch of "LINE VOL." to "100 V" or "70 V" and that of "INPUT" to the input power to be used.
- (2) When operating at low impedance;
Set both rotary switches of "LINE VOL." and "INPUT" to 8 Ω.

6. INSTALLATION

Step 1. Secure the swivel bracket to the ceiling or wall with 3 screws.

Before installation

Loosen the safety screw (for fall prevention) as shown below.

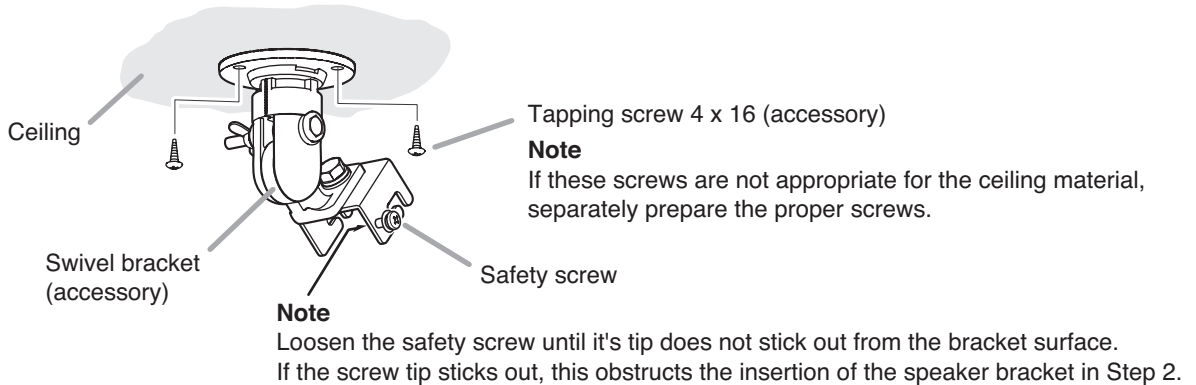

Step 2. Mount the speaker to the swivel bracket.

Before installation

Loosen the speaker fixing screws as shown below.

2-1. Pass the speaker cord through the cord entry hole in the swivel bracket.

2-2. Slip 2 speaker fixing screws into the swivel bracket's screw slots.

2-3. Tighten the speaker fixing screws and safety screw.

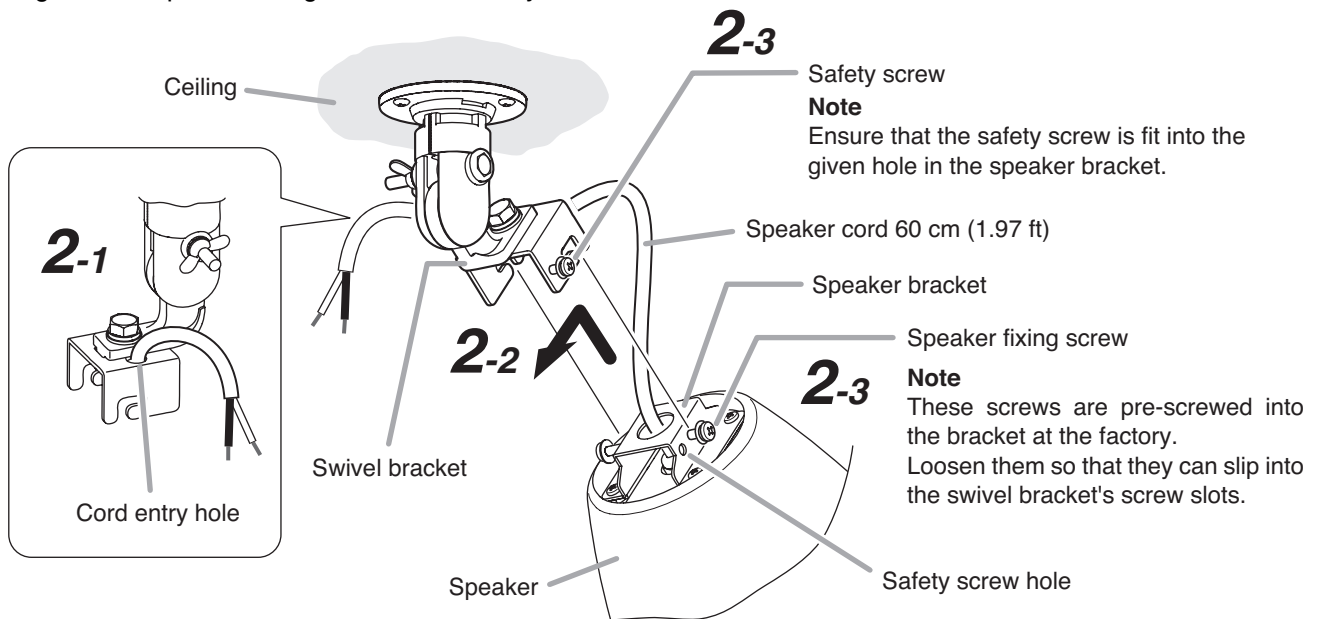

Step 3. Connect the 60 cm (1.97 ft) speaker cord to the routed speaker cable.

Step 4. Loosen the swivel bracket's butterfly nut, adjust the speaker angle, and then retighten the butterfly nut.

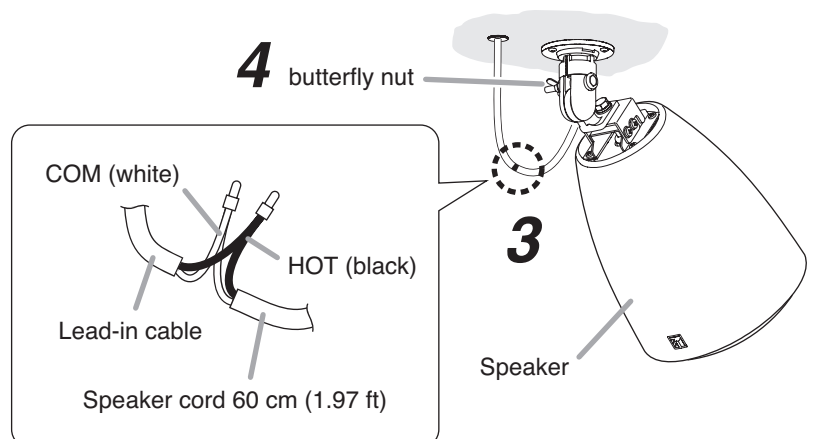

7. REPAINTING THE SPEAKER

Follow the procedure below when repainting the speaker cover and mesh net.

Note: Never touch the inner speaker diaphragm during work.

Step 1. Remove 4 screws that fix the speaker bracket to detach the speaker cover.

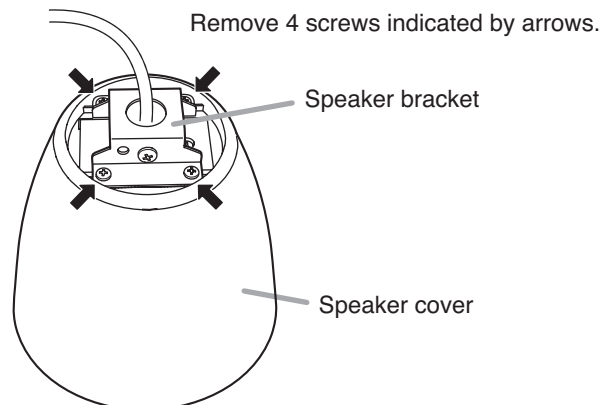

Step 2. Remove 3 screws that fix the mesh net, then raise the turndown tabs of the mesh net to detach.

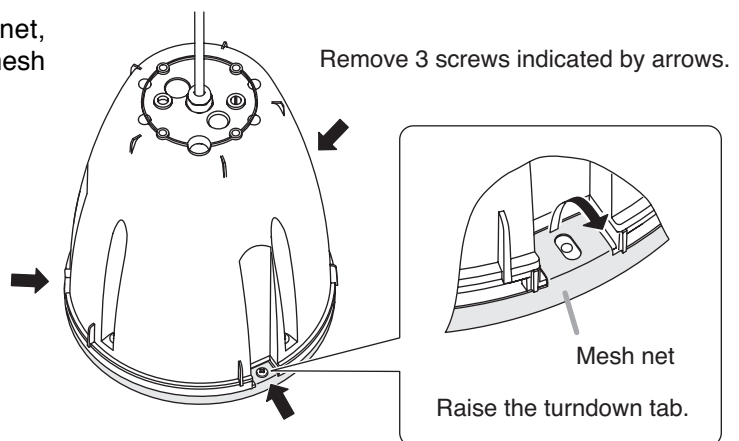

Step 3. Clean the speaker cover and mesh net.
Wipe with a soft cloth damped in a detergent.

Note

Do not use thinner or other volatile liquids to clean them as doing so may cause deformation.

Step 4. Use spray paint to apply uniform and thin coat of paint.

Notes

- Avoid painting with a roller or brush, as the mesh net could become clogged with paint.
- Use appropriate paints for the speaker cover and mesh net materials.
 - Speaker cover: Rolled steel plate (acrylic paint)
 - Mesh net: Fire-resistant HIPS resin

Step 5. After the paint has dried, apply another light coat.
Repeating Step 4, apply 2 or more light coats of paint. Application of one thick coat of paint all at once may cause drips or unevenness to show up in the painted finish, or clog the mesh holes.

Step 6. After the paint has dried, replace the speaker cover and mesh net.