

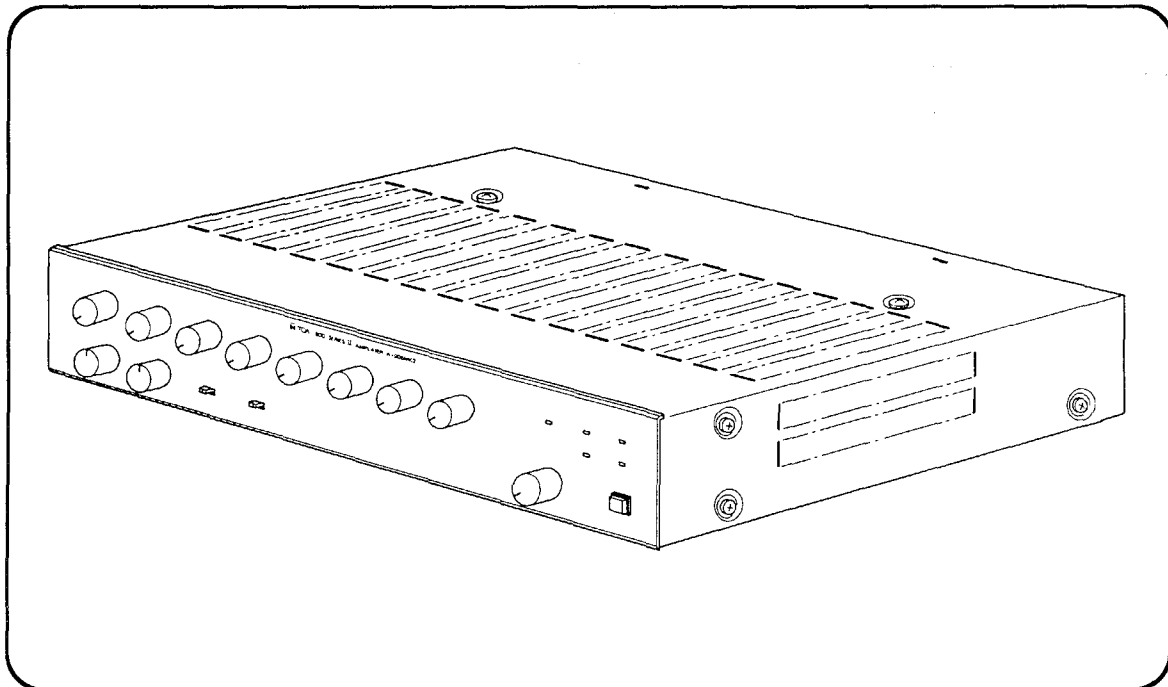



## Operating Instructions

### TOA 900 SERIES II MIXER POWER AMPLIFIER

**A-903MK2**  
**A-906MK2**  
**A-912MK2**



	<b>CAUTION</b> RISK OF ELECTRIC SHOCK DO NOT OPEN	
TO REDUCE THE RISK OF ELECTRICAL SHOCK, DO NOT REMOVE COVER. NO USER SERVICEABLE PARTS INSIDE. REFER SERVICING TO QUALIFIED SERVICE PERSONNEL.		



THE LIGHTNING FLASH WITH ARROWHEAD WITHIN A TRIANGLE IS INTENDED TO TELL THE USER THAT PARTS INSIDE THE PRODUCT ARE A RISK OF ELECTRIC SHOCK TO PERSONS.



THE EXCLAMATION POINT WITHIN A TRIANGLE IS INTENDED TO TELL THE USER THAT IMPORTANT OPERATING AND SERVICING INSTRUCTIONS ARE IN THE PAPERS WITH THE APPLIANCE.

Please follow the instructions in this manual to obtain the optimum results from this unit. We also recommend that you keep this manual handy for future reference.

## ■ Contents

General description .....	3
Features .....	3
Nomenclature	
Front panel .....	4
Rear panel .....	5
Input connections .....	6
Output connections (A-903MK2) .....	6~7
Output connections (A-906MK2/A-912MK2) .....	7~8
Muting and remote volume control connection .....	8
Rack mounting .....	8
Operation .....	9
Volume adjustment .....	9
Tone control adjustment .....	9
Installation .....	9
Servicing .....	9
Specifications .....	10
Appearance (A-903MK2) .....	11
Appearance (A-906MK2/A-912MK2) .....	12

## ■ General Description

The TOA A-903MK2, A-906MK2 and A-912MK2 Mixer Power Amplifiers control and mix up to eight independent input signals. The A-903MK2 delivers up to 30 watts of output power, the A-906MK2 60 watts and A-912MK2 120 watts.

Optional plug-in modules are available for use with these mixer power amplifiers to provide versatility for a wide range of operating applications. Edge connectors on the rear of the unit permit the selection of the TOA plug-in modules.

The mixer power amplifiers have output terminals to match 4- or 8-ohm speaker systems, or speaker distribution systems may be connected to 25- or 70-volt terminals, and can be rack mounted by using optional rack mounting bracket MB-25B. The optional perforated panel PF-511 provides suitable ventilation, finished in color to match the mixer power amplifiers.

## ■ Features

1. 8-channel mixer power amplifier
2. Wide frequency response : 20~20,000 Hz  $\pm$  1 dB
3. Low distortion and noise level
4. Remote master volume control
5. Excellent output regulation
6. Bass and treble controls
7. Bridging input/output
8. Self-protection circuitry design
9. Signal processing input/output
10. Varied output impedances : 4 ohms, 8 ohms, 25 and 70 volts
11. A full range of plug-in modules
12. Portable or rack mounting type

## ■ Nomenclature

### < Front Panel >

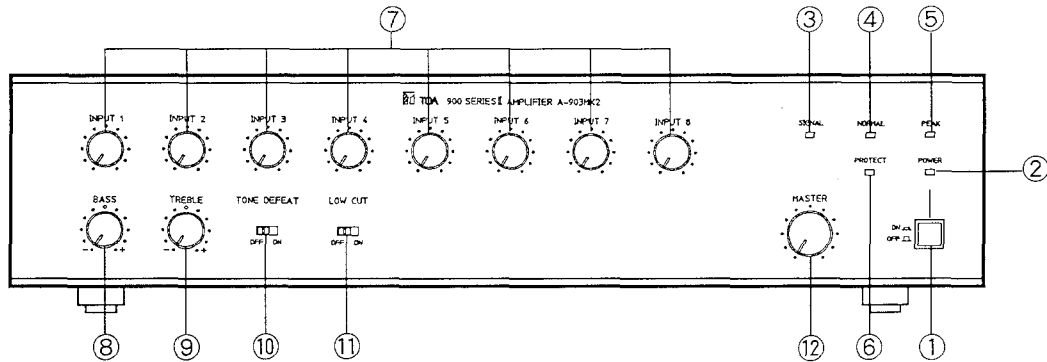

#### ① Power Switch

Applies line power. Two-position push button switch for on/off modes.

#### ② Power Indicator LED

Green LED lights when the power is switched "ON".

#### ③ Signal Indicator LED

Green LED lights when more than  $-30$  dB signal level is fed to the inputs by means of the input and master volume controls.

#### ④ Normal Indicator LED

Yellow LED lights when fed to the proper signal level.

#### ⑤ Peak Indicator LED

Red LED lights when amplifier approaches clipping level. If steady lit, the input level control should be turned down until the LED flashes only intermittently.

#### ⑥ Protection Indicator LED

Remains lit for about 5 seconds after power switch is turned ON.

#### ⑦ Input Volume Controls

Adjust gain of input #1 ~#8 respectively.

#### ⑧ Bass Control

Modifies bass response. Turn clockwise to boost, counter-clockwise to attenuate the bass response. Tone is flat at center.

#### ⑨ Treble Control

Modifies treble response. Turn clockwise to boost, counter-clockwise to attenuate the treble response. Tone is flat at center.

#### ⑩ Tone Switch

Selects ON/OFF of the BASS and TREBLE controls. When slided to OFF, BASS and TREBLE controls are active. When slided to ON, they become inactive to make tone flat.

#### ⑪ Low-Cut Switch

Cuts off unnecessary low frequency.

#### ⑫ Master Volume Control

Adjusts overall gain of the unit.

## < Rear Panel >

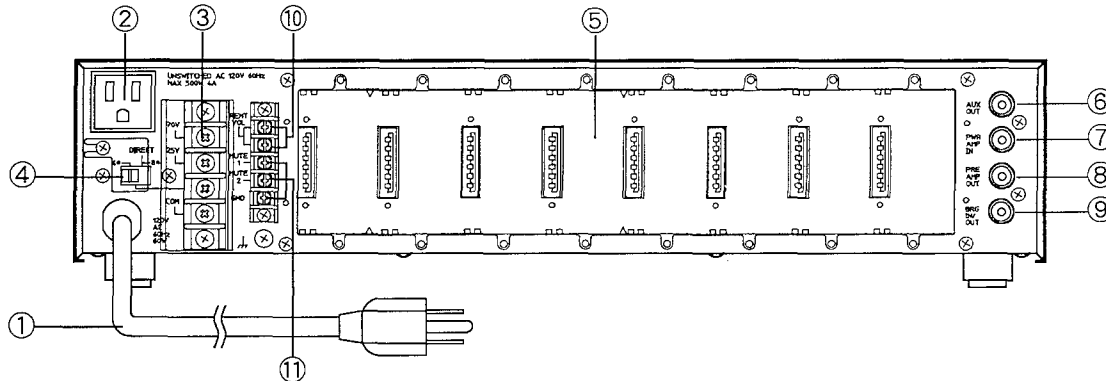

### ① AC Power Cord

Connects to power source.

### ② AC Outlet (Unswitched)

Provides AC power for auxiliary equipment with power consumption of up to 500W.

### ③ Output terminals

Connect to speakers.

### ④ Impedance Select Switch

Selects the desired impedance.

Enables unbalanced output of low impedance when this switch is set to "DIRECT".

### ⑤ Module Input Ports

Accepts optional PLUG-IN MODULES.

Module selection is determined by application.

For details, refer to Plug-in Module Instruction Manual.

### ⑥ AUX Out

Provides connections for a booster amplifier or tape recorder.

The input impedance of the equipment should be of more than 10k ohms.

### ⑦ Power Amp In

Connect to accessory equipment.

### ⑧ Preamp Out

Connects to a signal processing equipment such as a limiter, an equalizer, etc. The input impedances of the equipment should be of more than 600 ohms.

### ⑨ Bridging Input/Output

This terminal is used as a mixing bus. Mixing is achieved when the similar terminal of another amplifier is connected to this terminal. The output level taken from this terminal is independent of Master Volume Control, Bass and Treble Controls so that the terminal can also be used as recording output.

The input impedances of the equipment to be connected here should be of more than 10k ohms.

### ⑩ Remote Volume Control Terminals

Connecting a 10k linear taper potentiometer across these terminals will allow remote control of preamplifier output.

### ⑪ Mute terminals

Mutes input signals fed to plug-in modules employing muting function by short-circuiting at these terminals.

## Input Connections

There are eight INPUT PORTS for PLUG-IN MODULES.  
Select the desired modules for each application. Plug the modules into the INPUT PORTS.

Slide them between the guide rails and secure with two screws.

**CAUTION** : Modules should not be inserted or removed while the amplifier is turned on.

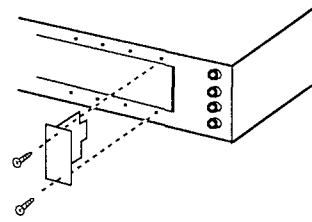

Cover unoccupied INPUT PORTS with blank panels. Secure blank panels with screws.

## Output Connections (A-903MK2)

The speaker outputs of the amplifier are 4 ohms, 8 ohms, 25V and 70V.

Connect speakers to any one of these outputs.

Class 2 wiring may be used.

There are two types of output;

- 4 ohms, 25V and 70V via output (matching) transformer
- 8-ohm direct output.

The connecting method differs in each case. Refer to the following diagrams.

**Note** : Impedances indicated below imply total speaker system (load) impedances.

### ● To connect speakers to outputs of : 4 ohms, 25V or 70V (BALANCED OUTPUT)

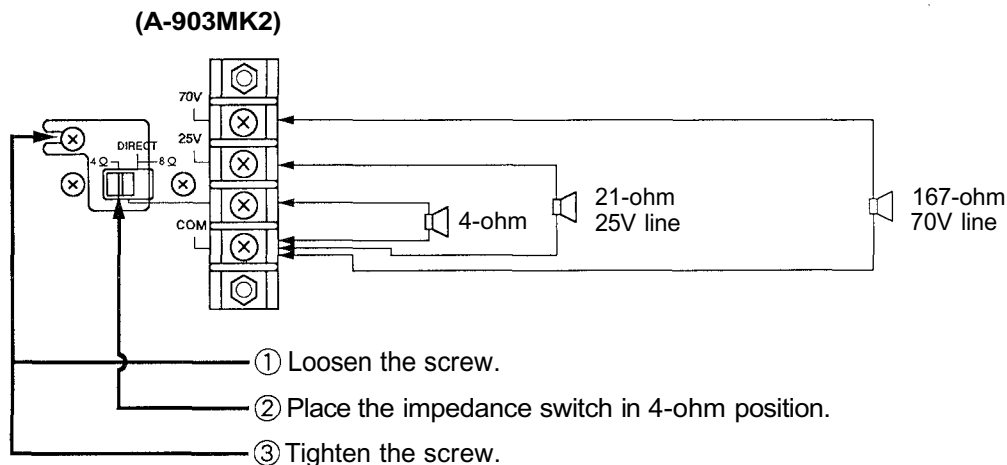

**Note** : Low-cut switch should be in "CUT" position.

Cut off unnecessary low frequency in TRANS OUTPUT to obtain best acoustic condition. The 900MK2 series amplifiers are characteristically flat even in the low frequency range. Thus, in TRANS OUTPUT the acoustic effect and frequency-response characteristics may be altered.

● To connect speakers to 8-ohm output (UNBALANCED DIRECT OUTPUT)

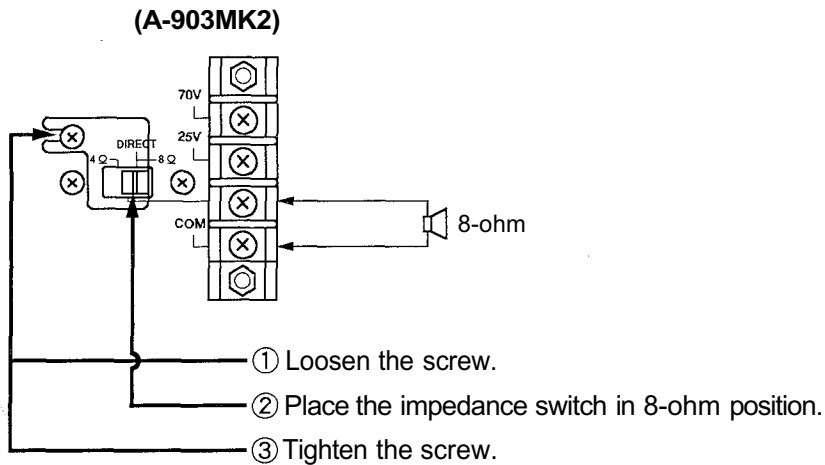

■ Output Connection (A-906MK2/A-912MK2)

The speaker outputs of the amplifier are 4 ohms, 8 ohms, 25V and 70V.

Connect speakers to any one of these outputs.

Class 2 wiring may be used.

There are two types of output ;

- 8 ohms, 25V and 70V via output (matching) transformer
- 4-ohm direct output.

The connecting method differs in each case. Refer to the following diagrams.

**Note :** Impedances indicated below imply total speaker system (load) impedances.

● To connect speakers to outputs of : 8 ohms, 25V or 70V (BALANCED OUTPUT)

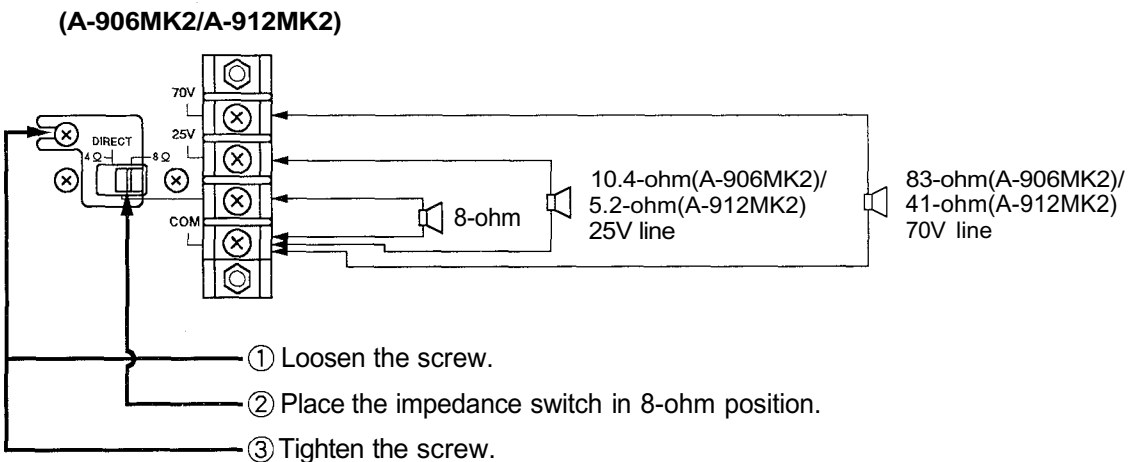

**Note :** Low-cut switch should be in "CUT" position.

Cut off unnecessary low frequency in TRANS OUTPUT to obtain best acoustic condition. The 900MK2 series amplifiers are characteristically flat even in the low frequency range. Thus, in TRANS OUTPUT the acoustic effect and frequency-response characteristics may be altered.

● To connect speakers to 4-ohm output (UNBALANCED DIRECT OUTPUT)

(A-906MK2/A-912MK2)

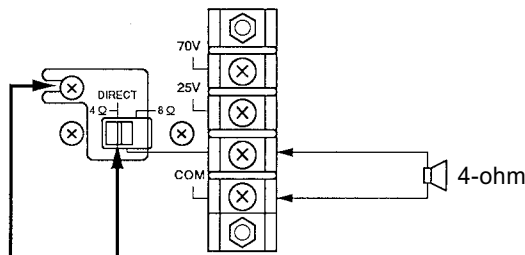

- ① Loosen the screw.
- ② Place the impedance switch in 4-ohm position.
- ③ After all connections are made, tighten the screw.

■ Muting and Remote Volume Control Connection

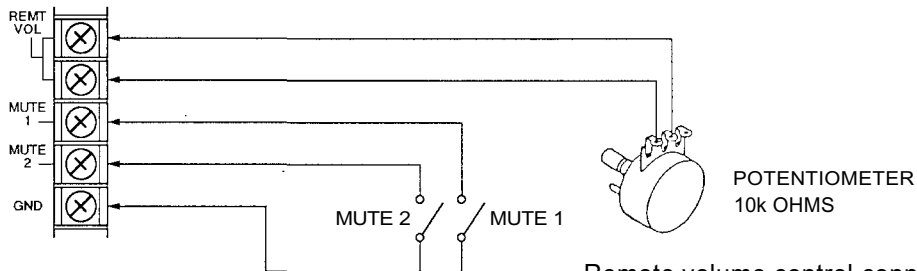

Remote volume control connection limiting front panel master volume control range.

■ Rack Mounting

To mount the amplifier in a standard 19" equipment rack, use the optional MB-25B rack mounting bracket.

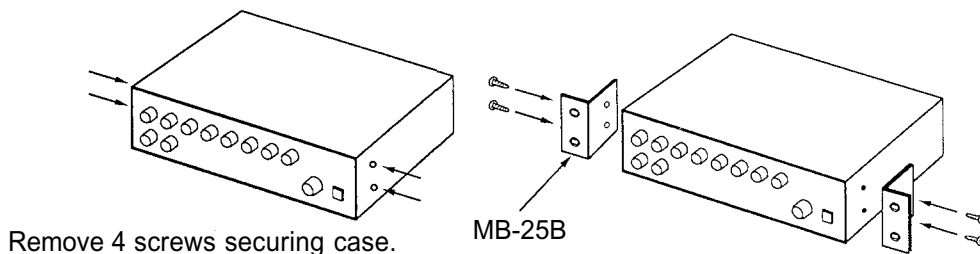

Remove 4 screws securing case.

MB-25B

Fix the brackets with attached 4 screws. The length of screws should not exceed 12mm (1/2").

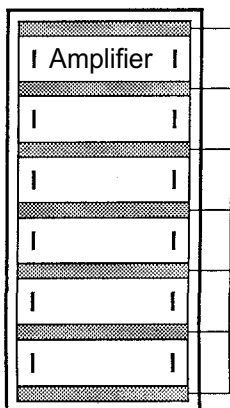

PF-511 perforated panel (1-unit size)

Use the perforated panel PF-511 to provide space for ventilation, when two or more units are mounted in an equipment rack. Contact your local TOA dealer for the perforated panel PF-511.



## ■ Operation

After all connections are made, turn power switch ON, illuminating the Power Indicator LED. The amplifier comes into operation approximately 5 seconds after the power is turned on.

## ■ Volume Adjustment

Obtain desired output level by adjusting the individual input and master volume controls. For normal music playing or announcement, adjust volume using their controls until the normal LED intermittently lights. Sound quality is deteriorated when the peak LED remains lit.

## ■ Tone Control Adjustment

Set the tone switch to the OFF position. This activates the bass and treble controls. The frequency response characteristics of each control are flat at center, boost in CW and attenuation in CCW positions. When tone controls are unnecessary, set the tone switch to ON mode.

## ■ Installation

Never block ventilation holes.

The amplifier should never be placed in areas

- exposed to direct sunlight.
- with high humidity or dust levels.
- with high ambient temperatures.
- susceptible to vibration.
- with poor ventilation.
- adjacent to heat-generating equipment.

**CAUTION** : Do not remove the case or you may encounter an electric shock.

**Note** : When the temperature of heat sink exceeds 105 °C the protection circuit is activated and the output is disconnected from the circuit. Output is automatically restored when the temperature return to normal operating parameter.

## ■ Servicing

### ● Unpacking

Upon receipt of the amplifier shipment, please inspect for any damage incurred in transit. If damage is found, please notify your local TOA representative and the transportation company immediately.

State date, nature of damage, whether any damage was noticed on the shipping container, prior to unpacking.

Please give waybill number of shipping order.

### ● Failure

Should amplifier fail, contact your nearest TOA authorized contractor or service center.

## ■ Specifications

	A-903MK2	A-906MK2	A-912MK2
Type	8-channel mixer power amplifier		
Output Power	30W RMS	60W RMS	120WRMS
Power Band Width	(D) 20 ~20,000 Hz, 0.5% THD (T) 50 ~20,000 Hz, 0.5% THD		
Frequency Response	(D) 20 ~20,000 Hz, ± 1 dB (T) 20 ~15,000 Hz, ± 1 dB (T) 20 ~20,000 Hz, +1 dB, -3 dB		
Total Harmonic Distortion	0.02% at 1 kHz, rated output		
Inputs	Eight Input Ports : Each port accepts any input module. One Bridging Input/Output		
Input Sensitivity/Impedance	Input Port #1 to #8 : 100 mV/10k ohms Bridging Input/Output: 100 mV/3.3k ohms		
Preamp OUT/Power Amp IN	1000 mV into 600 ohms/1000 mV, 10k ohms		
Outputs (T)=Transformer (D)=Direct	Main (T): 4 ohms, 25 & 70 volts, balanced Main (D): 8 ohms, unbalanced Aux : 10k ohms, 1V	Main (T) : 8 ohms, 25 & 70 volts, balanced Main (D) : 4 ohms, unbalanced , Aux : 10k ohms, 1V	
Output Regulation (1 kHz)	(D) Less than 0.5 dB, no load to full load (T) Less than 1.0 dB, no load to full load		
Signal to Noise Ratio (Band Pass 20 ~20,000 Hz) Tone Defeat SW ON	Master volume min : 90 dB Master volume max : 77 dB Power amplifier only : 105 dB		
Tone Controls	Bass : ± 10 dB at 100 Hz, Treble : ± 10 dB at 10 kHz		
Controls	8 Input gain controls                      1 Master gain control 1 Bass tone control                        1 Treble control 1 Power ON/OFF switch                    1 Tone defeat switch 1 Low-Cut switch (60 Hz, 6 dB/octave)		
Indicators	1 Power LED, 1 Protect LED, 1 Signal LED, 1 Normal LED, 1 Peak LED		
Protection	Self-protection, with AC fuse (inside)		
Connectors	Input No.1 to No.8..... Card-edge connector Bridging, Mixer preamp. output, Power amp. input, Aux output..... RCA phono jack Output..... Screw-terminal strip Mute, Remote VR..... Screw-terminal strip AC power cord/plug..... SJT, 3-prong type AC outlet..... 3-pin grounding type		
Power Consumption	60 W	100W	180W
Temperature Range	-10 °C ~ +60 °C [12°F~140°F]		
Dimensions (W) x (H) x (D)	420 x 99.1 x 318 mm [16.5 X3.9X 12.5 in.]	420 x 99.1 x 358 mm [16.5 X3.9X 14.1 in.]	
Weight	7.8 kg [17.2 lb.]	9.6kg [21.2lb.]	11.4 kg [25.1 lb.]
Color	Black		
Standard Accessories	4 Volume control covers (YA-920)		
Other Features	Output disconnected for approx. 5 seconds after switching power on.		

\* Specifications are subject to change without notice.

# ■ Appearance (A-903MK2)

< Front View >

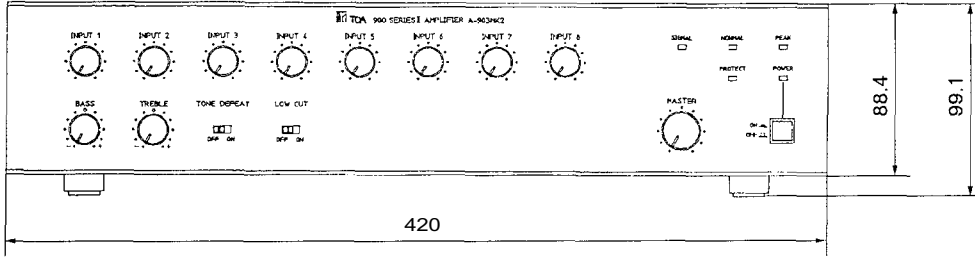

< Rear View >

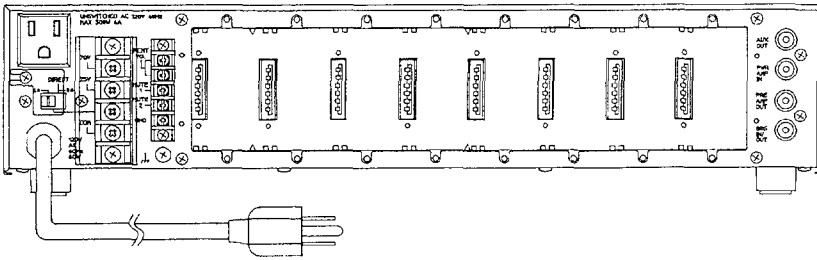

< Top View >

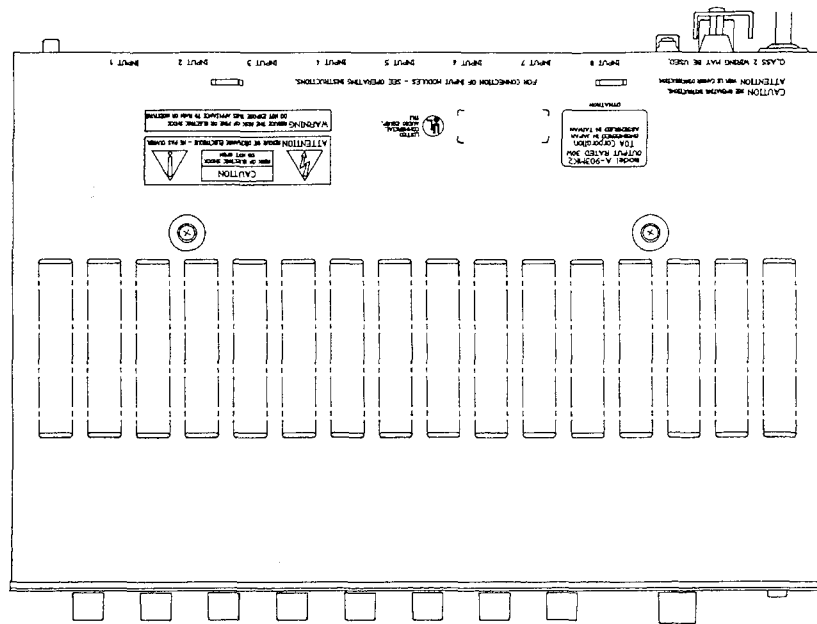

< Side View >

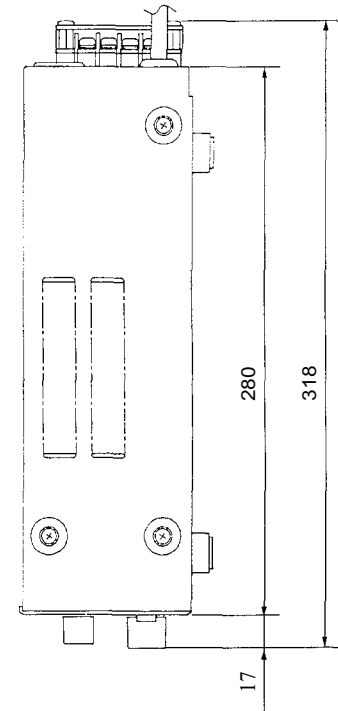

**■ Appearance (A-906MK2/A-912MK2)**

< Front View >

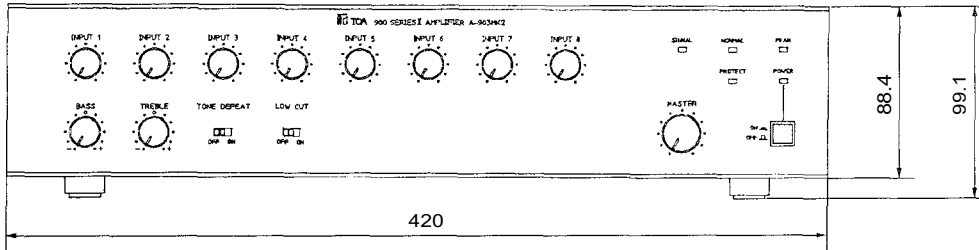

< Rear View >

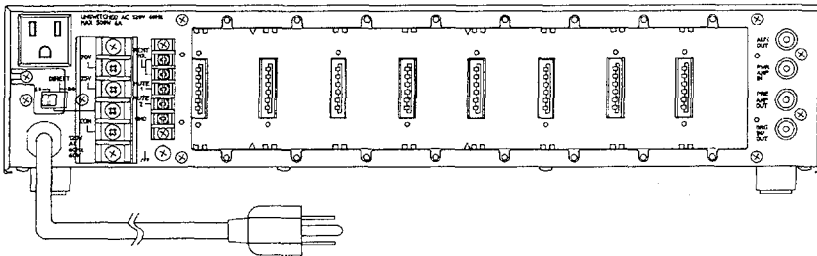

< Top View >

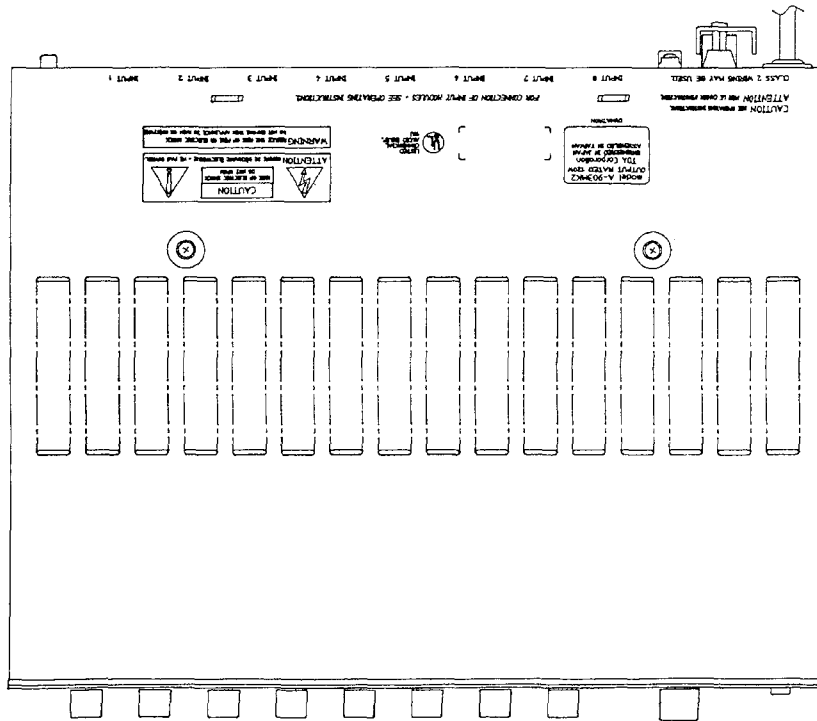

< Side View >

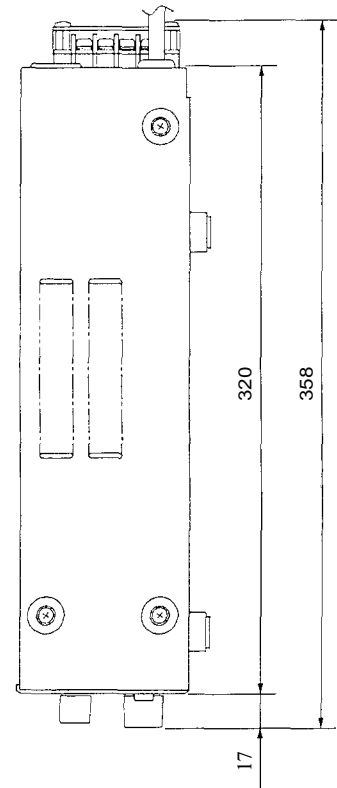

TOA Corporation  
KOBE, JAPAN