



OPERATING INSTRUCTIONS

UHF WIRELESS MICROPHONE **WM-5320** **WM-5320A** **WM-5320H**

Thank you for purchasing TOA's UHF Wireless Microphone.
Please carefully follow the instructions in this manual to ensure long, trouble-free use of your equipment.

TABLE OF CONTENTS

1. SAFETY PRECAUTIONS	2
2. GENERAL DESCRIPTION	2
3. FEATURES	2
4. HANDLING PRECAUTIONS	3
5. NOMENCLATURE	3
6. BATTERY INSERTION	5
7. CHANNEL NUMBER SETTING	6
8. OPERATION	6
9. OPERATIONAL HINTS	7
10. DISTANCE BETWEEN THE MICROPHONE AND THE MOUTH	7
11. AUDIO LEVEL ADJUSTMENT (SENSITIVITY CONTROL)	7
12. SPECIFICATIONS	8

1. SAFETY PRECAUTIONS

- Be sure to read the instructions in this section carefully before use.
- Make sure to observe the instructions in this manual as the conventions of safety symbols and messages regarded as very important precautions are included.
- We also recommend you keep this instruction manual handy for future reference.

Safety Symbol and Message Conventions

Safety symbols and messages described below are used in this manual to prevent bodily injury and property damage which could result from mishandling. Before operating your product, read this manual first and understand the safety symbols and messages so you are thoroughly aware of the potential safety hazards.



WARNING

Indicates a potentially hazardous situation which, if mishandled, could result in death or serious personal injury.

- To prevent the electromagnetic wave from badly influencing medical equipment, make sure to switch off the unit's power when placing it in close proximity to the medical equipment.



CAUTION

Indicates a potentially hazardous situation which, if mishandled, could result in moderate or minor personal injury, and/or property damage.

- When the unit is not in use for 10 days or more, be sure to take the battery out of the unit because battery leakage may cause personal injury or contamination of environment.
- Make sure to observe the following handling precautions so that a fire or personal injury does not result from leakage or explosion of the battery.
 - Do not short, disassemble, heat nor put the battery into a fire.
 - Never charge batteries of the type which are not rechargeable.
 - Do not solder a battery directly.
 - Be sure to use the specified type of battery.
 - Note correct polarity (positive and negative orientation) when inserting a battery in the unit.
 - Avoid locations exposed to the direct sunlight, high temperature and high humidity when storing batteries.

CAUTION TO USER: Changes or modifications not expressly approved by the party responsible for compliance could void the user's authority to operate the equipment.

2. GENERAL DESCRIPTION

The TOA's WM-5320 is a lapel wireless microphone, and the WM-5320A and WM-5320H are headset wireless microphones, which are all designed for speech use.

The WM-5320 employs an omni-directional electret condenser microphone element, while the WM-5320A and WM-5320H employ unidirectional electret condenser microphone elements.

The WM-5320A differs from the WM-5320H in that the WM-5320A features sweat-proof design and is supplied with a waist pouch.

3. FEATURES

- One frequency can be selected from 64 frequencies (16 channels x 4 banks) of 636 – 698 MHz.
- An optimized PLL-synthesizer minimizes the oscillation frequency drift resulting from the ambient temperature or voltage fluctuation.
- Audio level control adjusts the microphone sensitivity.
- Power/Battery lamps indicate battery consumption to prevent the unit from malfunctioning when the battery level remarkably decreases.
- Compact and high reliability
- Sweat-proof handset with an adjustable fixing band is exclusively designed for use by aerobics instructors. (WM-5320A only)

- Operates on a single AA battery.
- Employs a built-in antenna.
- The state of battery consumption can be displayed on the tuner's indicator when the unit is used in conjunction with the optional WT-5800, WT-5805 or WT-5810 Wireless Tuner.

4. HANDLING PRECAUTIONS

- Do not expose the unit to rain or an environment where it may be splashed by water or other liquids, as doing so may result in unit failure.
- Never open nor remove the unit case to modify the unit. Refer all servicing to your nearest TOA dealer.
- Take care not to drop the unit onto the floor nor bump it against a hard object as the unit could fall.
- Do not place the unit in locations of high temperature (ex. in an ill-ventilated car in summer) or high humidity as the unit could fail.
- Do not use the unit in locations where it is exposed to seawater.
- To clean, use a dry cloth. When the unit gets very dirty, wipe lightly with a cloth damped in a dilute neutral cleanser, then wipe with a dry cloth. Never use benzine, thinner, or chemically-treated cleaning towel.
- Avoid using a mobile telephone near the wireless microphone in use. Noise could be picked up.
- When using two or more wireless microphones, keep them at least 50 cm away from each other to avoid malfunctions or noise.
- Keep the wireless microphone at least 3 m away from the receiving antenna. Using the microphone in close proximity to the antenna could result in malfunctions or noise.

5. NOMENCLATURE

[Main unit]

Unit: mm

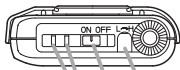

Audio level control
Power ON/OFF switch
Power/Battery lamps

A green LED lights as long as the battery capacity is sufficient.
When the battery capacity becomes low, the green LED starts to dim, while the red LED to light.

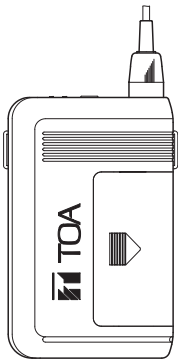

Inside of a battery cover

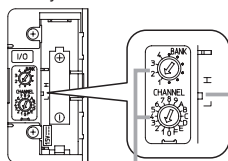

Channel setting switch

Keep the switch in the "L" position (factory-preset).
Leave the switch setting to qualified service technicians.

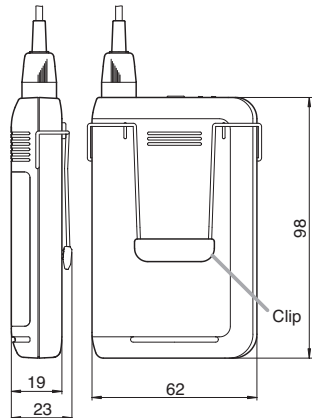

Neck strap attachment

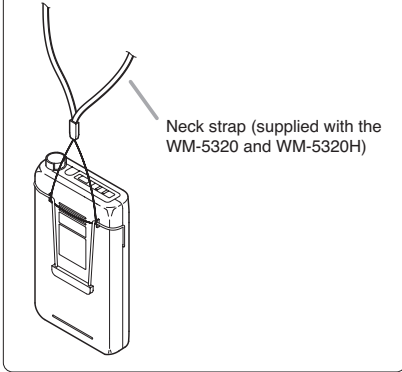

[Microphone unit] (WM-5320 only)

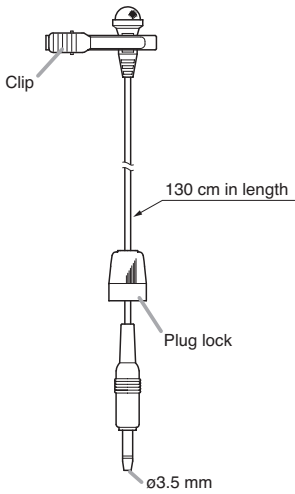

Tie-clip attachment

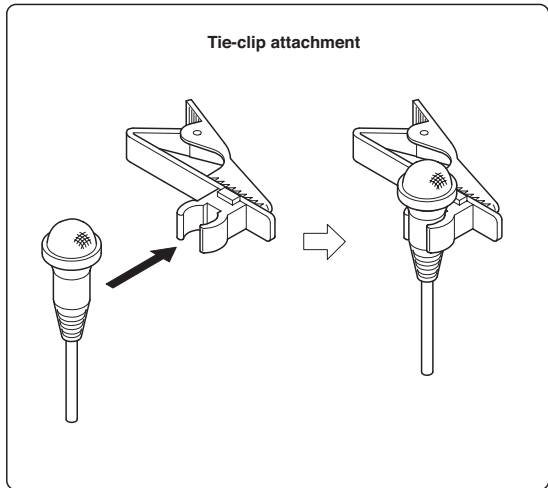

[Headset] (WM-5320A only)

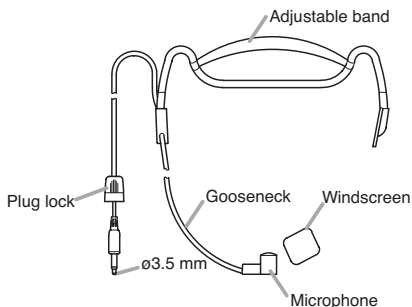

[Headset] (WM-5320H only)

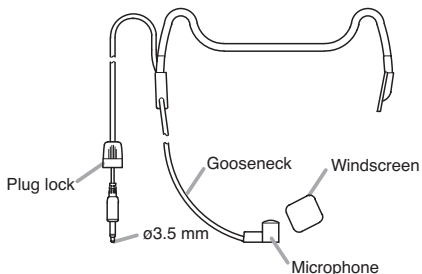

Note: Windscreens are also available as optional product WH-4000S.

[Waist pouch] (WM-5320A only)

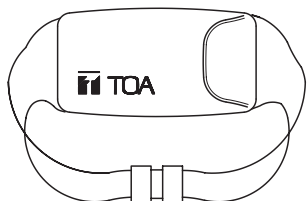

6. BATTERY INSERTION

Step 1. Turn off the power switch.

Step 2. Remove the battery cover from the unit.
Slide the battery cover in the direction indicated by the arrow while pushing down the cover with a thumb as shown in the figure.

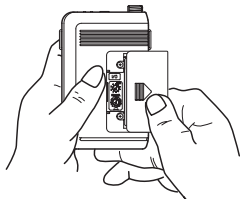

Step 3. Insert an AA battery according to (+) and (-) indications on the battery compartment.

Step 4. Replace the removed battery cover.

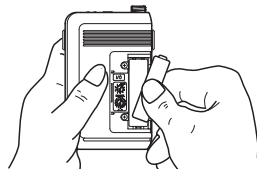

Battery replacement

- A brand-new AA alkaline battery will continuously operate the unit for about 10 hours.
- When the battery capacity becomes low, the green LED of the Power/ Battery lamps starts to dim, while the red LED to light. When only the red LED lights, replace the battery with a new one. In this condition, the unit transmits the remaining battery capacity information to the tuner, causing the tuner's BATT indicator to light.

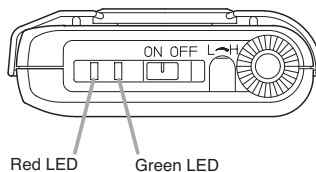

7. CHANNEL NUMBER SETTING

Step 1. Turn off the power switch, and then remove the battery cover.

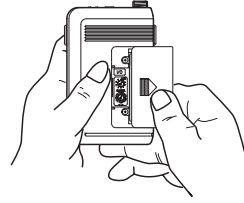

Step 2. Using the supplied screwdriver, set the Channel setting switch pointer to the desired channel number.

Channel setting switch

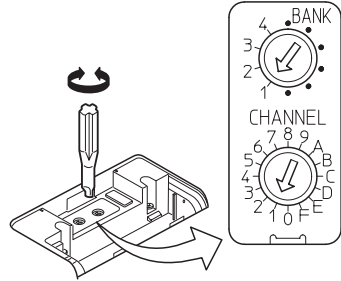

Step 3. Replace the battery cover.

Note

Make sure that the wireless microphone is identical to the wireless tuner in the channel number. Should the microphone's setting differ from that of the tuner, the tuner does not receive the microphone signal.

8. OPERATION

Step 1. Plug the microphone's plug into the input connector as illustrated.

Step 2. Confirm that the wireless microphone and the wireless tuner are identical in the channel number. If not identical, turn the power ON/OFF switch to the OFF position, then set the channel number to the same channel number as the tuner.

Step 3. Turn the Power ON/OFF switch to the ON position. Then, confirm the green LED of the Power/Battery lamps will light. For the WM-5320A, put the unit into the waist pouch as shown in the figure below.

Step 4. Turn the Power ON/OFF switch to the OFF position after use.

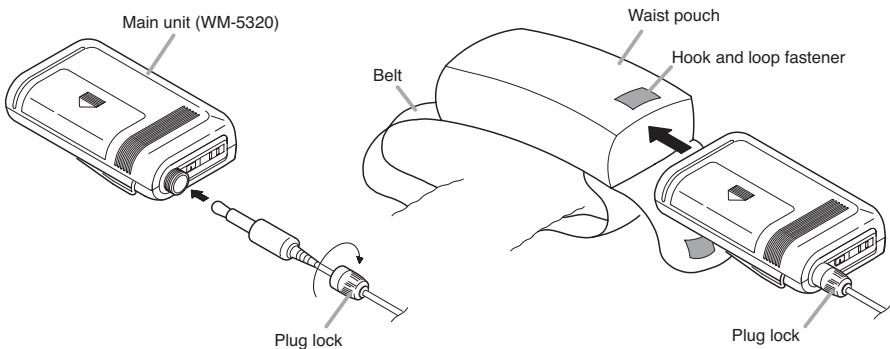

Secure the connection with the plug lock.

Illustration for WM-5320A

9. OPERATIONAL HINTS

- The microphone's service distance is 3 – 120 m. When the microphone user moves in a facility, signal dropouts (momentary losses of signal reception) may be encountered. These dropouts are caused by the building's architectural designs or materials which block the travel of or reflect the radio signal. If this occurs, the user needs to change locations for better signal reception.
- The proper operation of your wireless system may be interfered with by other system operating on the same frequency. In such cases, change the operating frequency of your system. (As to dealing with the interference, refer to the operating instructions of the wireless tuner.)
- Should you have any questions regarding the use or availability of TOA wireless products, please contact your local TOA dealer.

10. DISTANCE BETWEEN THE MICROPHONE AND THE MOUTH

[Lapel Wireless Microphone WM-5320]

Keep your mouth 15 – 20 cm away from the microphone for the best possible sound reproduction. Take care not to bring your mouth too close to the microphone (within 5 cm) as this impairs speech clarity if you speak loudly.

[Headset Wireless Microphones WM-5320A and WM-5320H]

By adjusting the gooseneck, locate the microphone with the supplied windscreen in front of your mouth, and position it 3 – 5 cm away from your mouth for the best sound reproduction. When the microphone is too close to your mouth or you speak too loud, speech clarity will be impaired, making it hard for the audience to hear announcements.

11. AUDIO LEVEL ADJUSTMENT (SENSITIVITY CONTROL)

To change the factory-preset level, follow the procedures below.

Step 1. Holding the microphone body, open the rubber cap as illustrated.

Step 2. Switch on the power of the tuner and microphone.

Step 3. Adjust the audio level control using the supplied screwdriver. The microphone sensitivity increases as the control is rotated clockwise, and decreases as rotated counterclockwise.

Step 4. Adjust the corresponding tuner's volume control so that its knob points to the 2 o'clock position. If the tuner's AF peak lamp remains lit, readjust the microphone's audio level control to the position that causes the indicator to flash when the tuner output level reaches its peak. The AF peak lamp lights when the output level reaches the point of about 3 dB below the clipping level.

Note

The AF peak lamp operates in response to the volume control position.

However, the AF level lamp on the LCD (on the WT-5800/5805) indicates the level regardless of the volume control setting.

Step 5. Replace the battery cover.

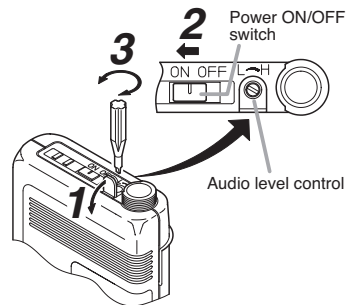

12. SPECIFICATIONS

[WM-5320]

Microphone Element	Electret condenser type, omni-directional pattern
Modulation	Frequency modulation
Frequency Range	636 – 698 MHz, UHF
Selectable Channel	64 frequencies (the number of channels may differ from country to country.)
RF Carrier Power	Less than 50 mW
Tone Frequency	32.768 kHz
Oscillator	PLL synthesized
Maximum Input Level	110 dB SPL (Audio level control: Maximum position)
Battery	LR6 (AA)
Battery Life	More than 10 hours (alkaline)
Indicator	Power/Battery lamps
Antenna	Built-in type
Operating Temperature	-10 to +50°C
Finish	Resin, coating
Dimensions	62 (w) x 102.5 (h) x 23 (d) mm
Weight	110 g (with battery)

Note: The design and specifications are subject to change without notice for improvement.

• Accessories

Screwdriver (for setting)	1	Neck strap	1
Storage case	1		

[WM-5320A, WM-5320H]

Main unit	
Modulation	Frequency modulation
Frequency Range	636 – 698 MHz, UHF
Selectable Channel	64 frequencies (the number of channels may differ from country to country.)
RF Carrier Power	Less than 50 mW
Tone Frequency	32.768 kHz
Oscillator	PLL synthesized
Maximum Input Level	120 dB SPL
Battery	LR6 (AA)
Battery Life	More than 10 hours (alkaline)
Indicator	Power/Battery lamps
Antenna	Built-in type
Operating Temperature	-10 to +50°C
Finish	Resin, coating
Dimensions	62 (w) x 102.5 (h) x 23 (d) mm
Weight	90 g (with battery)
Headset	
Microphone Element	Electret type, cardioid pattern
Cable Length	1.4 m
Connector	ø3.5 mm mini-plug

Note: The design and specifications are subject to change without notice for improvement.

• Accessories

Screwdriver (for setting)	1	Neck strap (WM-5320H only)	1
Waist pouch (WM-5320A only)	1		

License requirement

The term "IC:" before the radio certification number only signifies that Industry Canada Technical specifications were met. Operation is subject to the following two conditions:

(1) This device may not cause harmful interference, and (2) this device must accept any interference received, including interference that may cause undesired operation.

IMPORTANT NOTE: To comply with the FCC RF exposure compliance requirements, no change to the antenna or the device is permitted. Any change to the antenna or the device could result in the device exceeding the RF exposure requirements and void user's authority to operate the device.

